

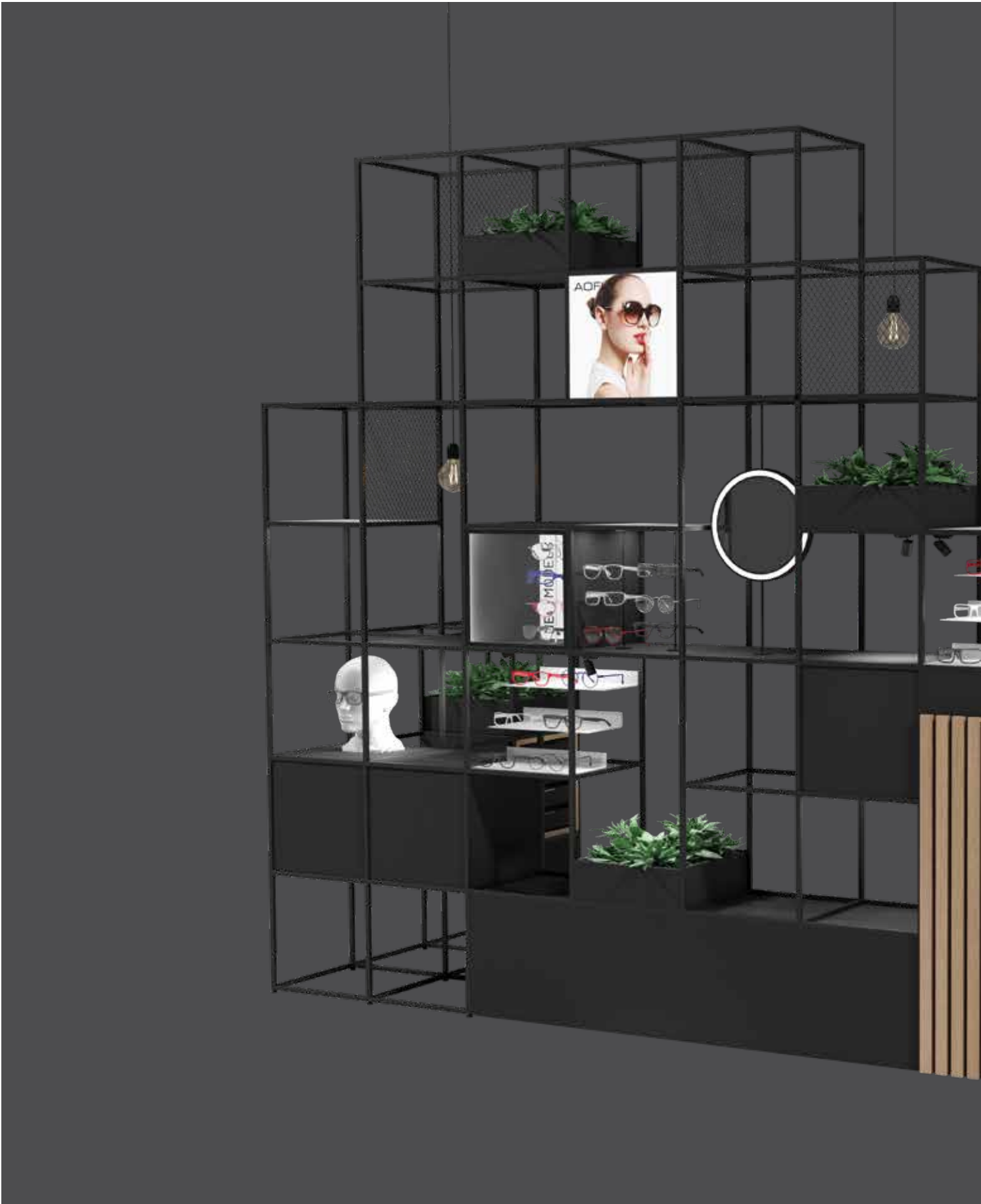

STRUKTURA

CONTENT

| | |
|-----------------------------------|----|
| ABOUT STRUKTURA | 03 |
| CONSTRUCTION | 04 |
| BASIC SETS | 05 |
| CORDLESS LED-LIGHTING | 06 |
| SHELVES & SIDE PLATES | 10 |
| SHELVING & CABINET SETS | 12 |
| INSERT SHELVING SETS | 14 |
| INSERT ELEMENTS & ACCESSORIES | 16 |
| DISPLAYS WITH RODS | 30 |
| SHELVING DISPLAYS | 32 |
| MOSAIC SHELVES | 36 |
| CLEAR LOOK DISPLAYS | 40 |
| MULTI PIN DISPLAYS | 42 |
| ADVERTISING ELEMENTS & CABINETS | 44 |
| SHOP WINDOW DISPLAYS | 48 |
| ISLAND DISPLAYS STANDS & CABINETS | 50 |
| WORKING PROCESS | 52 |
| SHOWROOM | 54 |





ABOUT STRUKTURA



The modularity of the system enables countless design combinations and highly versatile applications, all with fully personalized dimensions.



System comes with a unique cordless white LED lighting — integrated lighting without the use of cables. Applicable to all areas of the store, from shop windows to central spaces.



The structure is extremely strong and stable, without the need for additional safety construction elements.



Due to the simplicity of the basic components, the assembly process is very quick, making also transportation process more efficient.

CONSTRUCTION

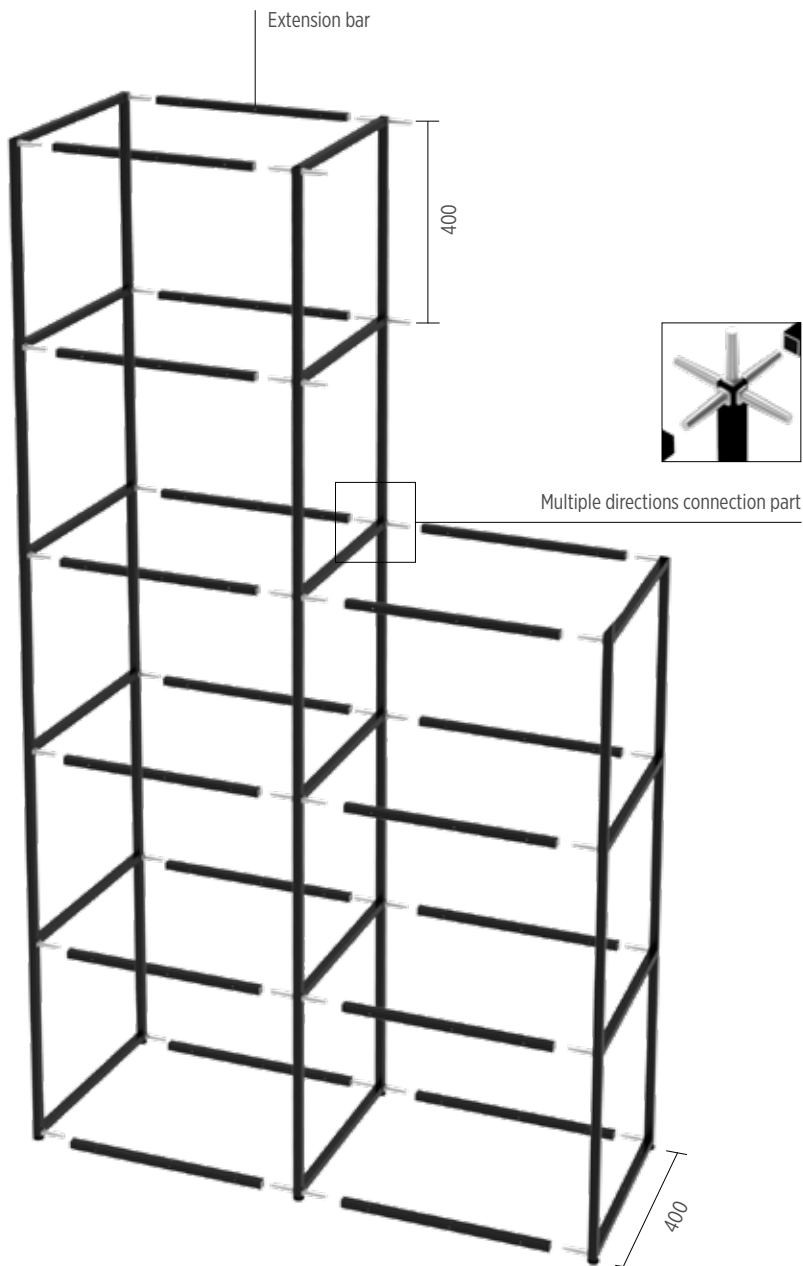

Aluminium bars form the basis of the system construction. They are only 15 mm thick and are available in standard aluminium gray, as well as with black and white powder coating.

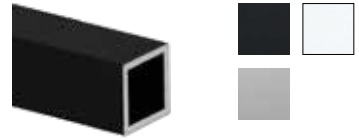

The unique method of connecting the bars* allows for easy and quick assembly of various cubic structures — no tools required. Very simple and convenient for creating completely personalised design solutions.

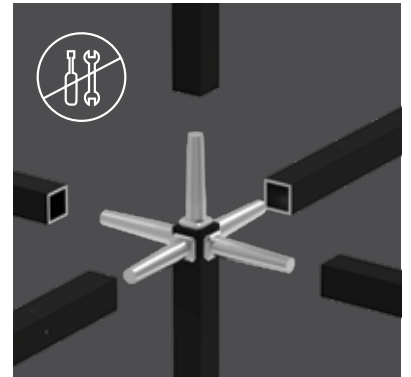

The resulting structures are very strong and stable.



*The product is in the patent application process.
UE No.22 206 949.4

BASIC SETS

 Extension bar, sold in pair (2 pcs.)

STK.EXT
38,00 €

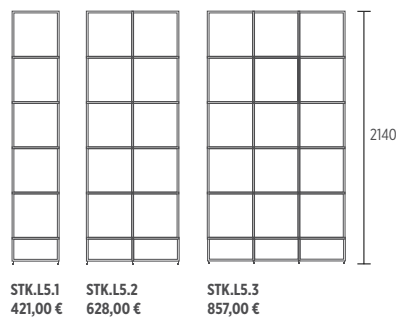
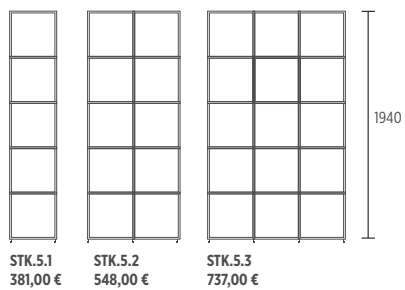
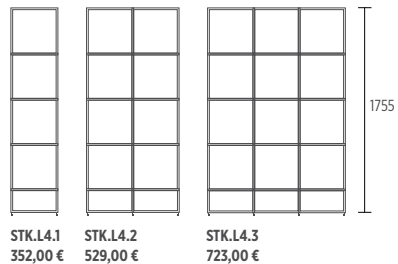
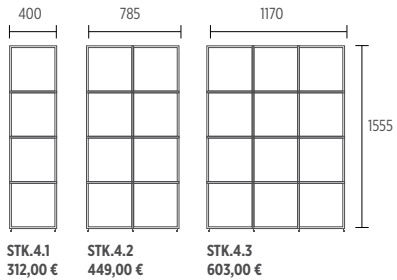
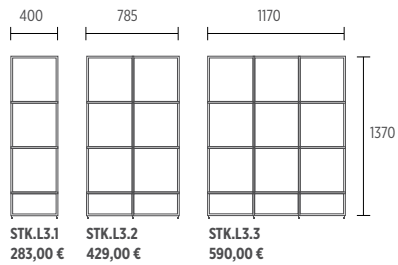
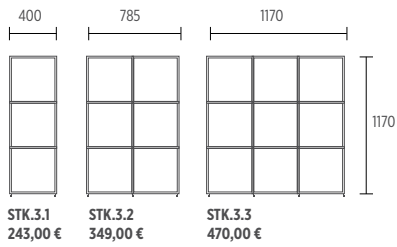
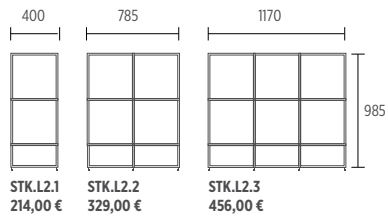
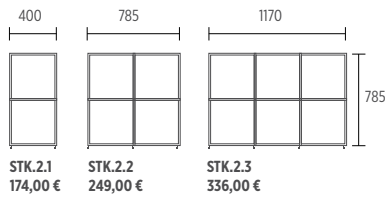
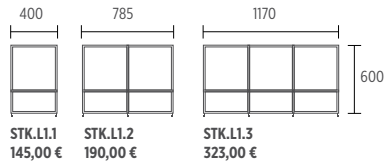
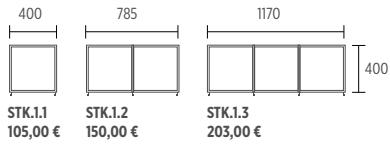

Hanging elements for shop window



CORDLESS LED LIGHTING

One of the distinctive features that sets the Struktura system apart from similar products on the market is its unique integrated lighting without cables. The entire system, whether it's a single cube or a large composition of 20 or more cubes, can be illuminated with equal intensity in any part of the space.

Electricity is conducted through the bars themselves and operates based on the principle of polarity. As a result, the lighting turns on or off depending on the installed elements.

The light is specifically facilitated through LED shelves, which are available in three types.

The first type of LED shelf is equipped with movable mini spotlights, ideal for situations where directed lighting is needed.

The second type includes a movable LED bar, allowing for various light adjustments.

The third and final LED shelf features integrated LED strips that provide uniform illumination.



INSERT LED PLATES

SPOTLIGHT LED lighting

TOP view

STK.IPHL



BOTTOM view

STK.SH

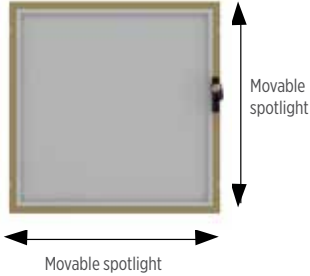

Spotlight — 3500 K, 6000 K



White acrylic insert plate for spotlight/LED bar.
369x369x10 mm
STK.IPHL 38,00 €

Spotlight holder
370x10x10 mm
STK.SH 10,00 €

Spotlight, small — 1,5 w **SPS** 28,00 €
Spotlight, large — 2 w **SPL** 35,00 €
Set of 2 spotlights — 3 w **SP2S** 48,00 €

STK.SH



Movable bar with LED lighting

TOP view

STK.IPHL

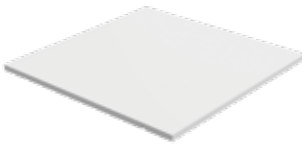

BOTTOM view

STK.LS

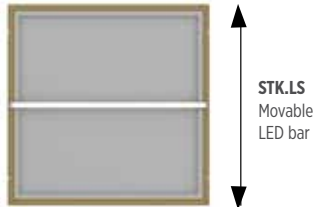

White acrylic insert plate for LED bar/spotlight.
369x369x10 mm
STK.IPHL 38,00 €

Movable LED bar
370x10x10 mm
STK.LS 34,00 €

STK.LS



LED stripes

TOP view

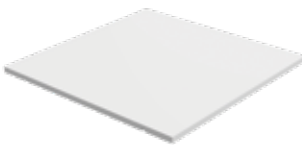

BOTTOM view

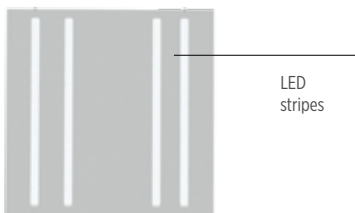

White acrylic insert plate with integrated white LED stripes.

369x369x10 mm
STK.IP.LL 102,00 €

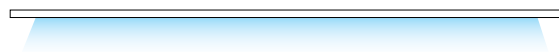

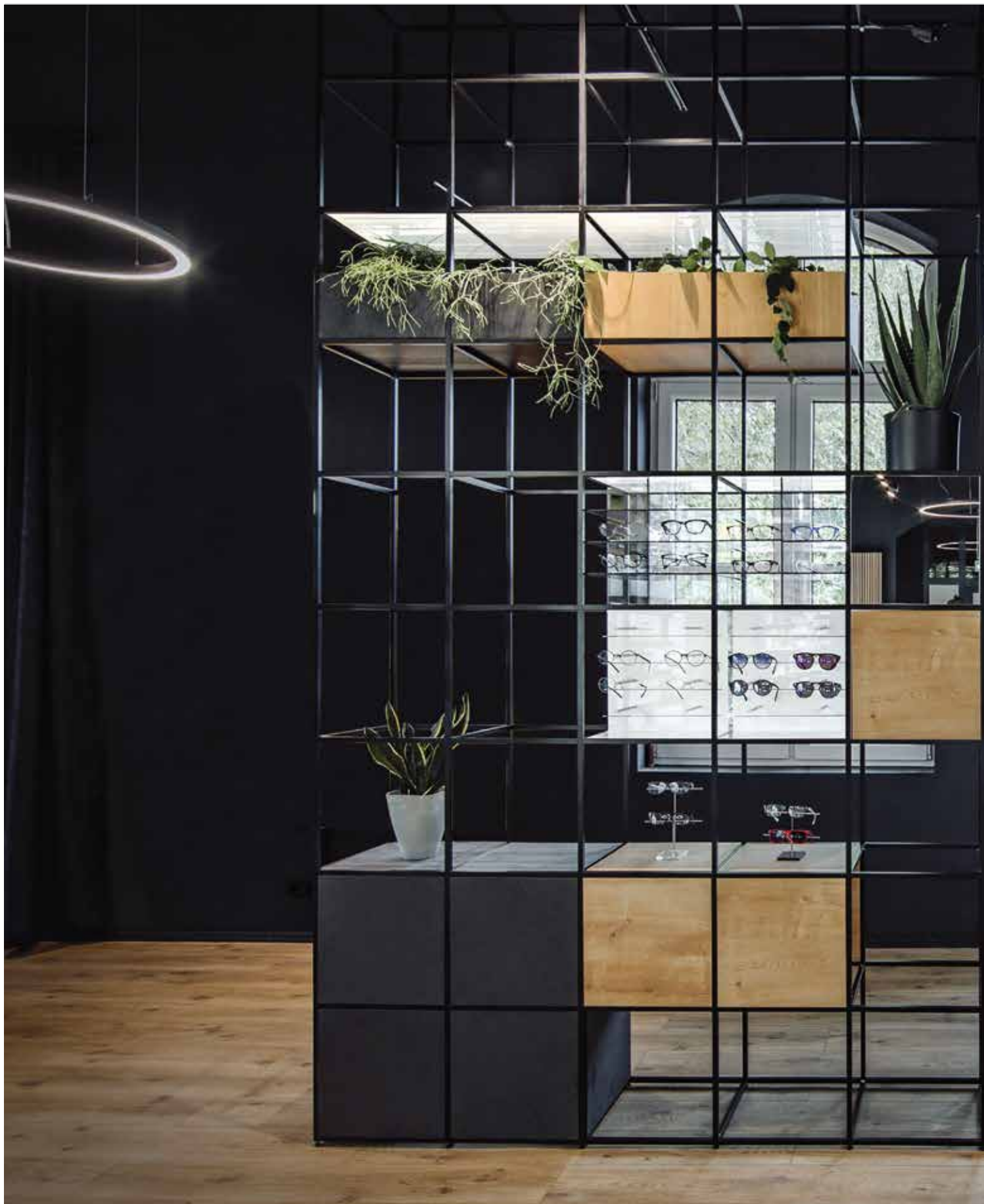



SHELVES & SIDE PLATES

INSERT PLATE

Installed inside the construction

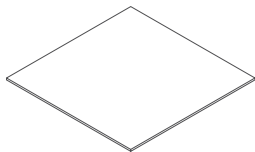

Acrylic white, black
369x369x5 mm
STK.IP.A5

32,00 €

MDF white, black, grey, oak
369x369x8 mm
STK.IP.M8

23,00 €

COVER PLATE

Installed inside the construction

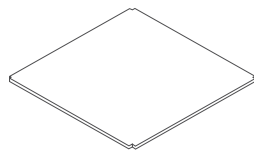

Acrylic white, black
385x400x5 mm
STK.CP.A5

32,00 €

MDF white, black, grey, oak
385x400x8 mm
STK.CP.M8

23,00 €

Derived timber white, black, oak
385x400x19 mm
STK.CP.M8

22,00 €

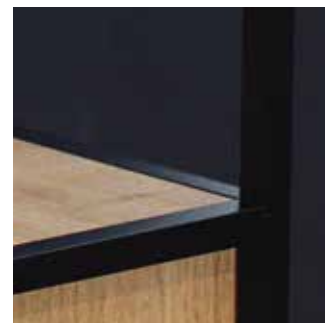

TOP PLATE

Installed on the construction

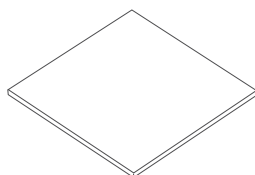

Acrylic white, black
400x400x5 mm STK.A5.1 32,00 €
785x400x5 mm STK.A5.2 61,00 €
1170x400x5 mm STK.A5.3 89,00 €

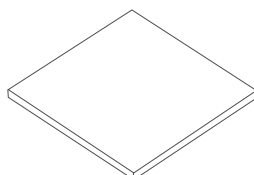

MDF white, black, grey, oak
400x400x8 mm STK.M8.1 23,00 €
785x400x8 mm STK.M8.2 42,00 €
1170x400x8 mm STK.M8.3 59,00 €

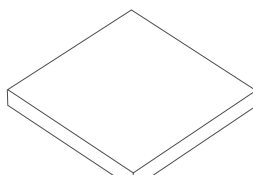

Derived timber white, black, oak
400x400x19 mm STK.DT19.1 22,00 €
785x400x19 mm STK.DT19.2 32,00 €
1170x400x19 mm STK.DT19.3 42,00 €



SIDE PLATES

Installed inside the construction

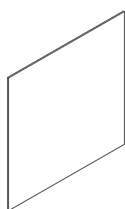

Acrylic white, black
369x369x3 mm
STK.SP.A3

25,00 €

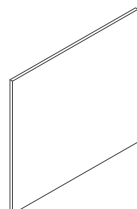

MDF white, black, grey, oak
385x400x8 mm
STK.SP.M8

24,00 €

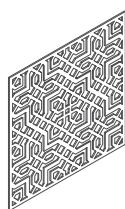

Custom decor cut on acrylic
385x400x3 mm
STK.D.P

52,00 €



Advertising plate
transparent acrylic
385x400x3 mm
STK.AP

52,00 €



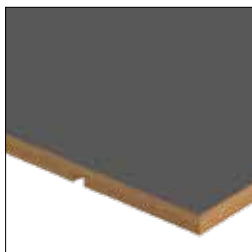
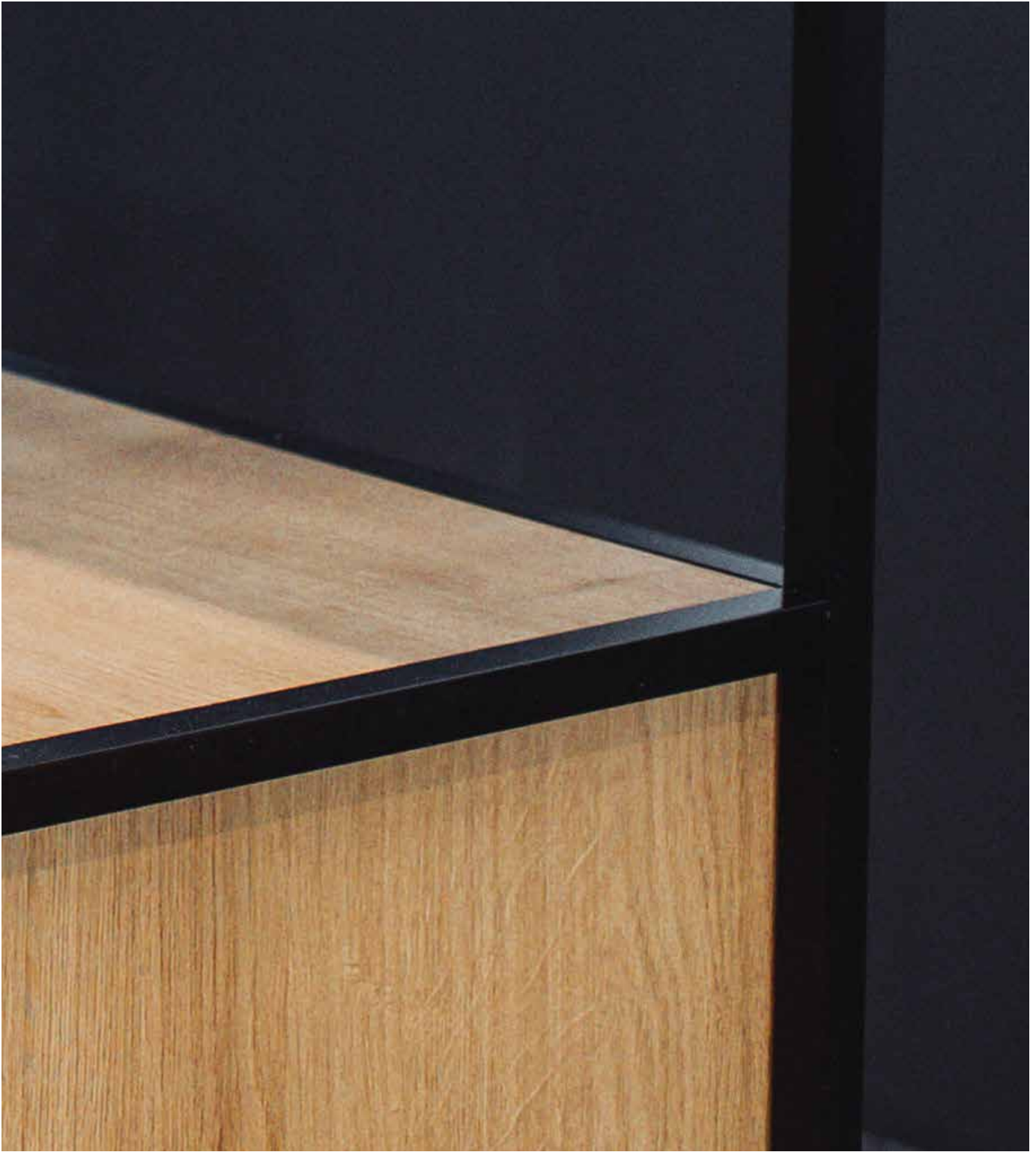

NO TOOLS REQUIRED

Plates are simply inserted into the structure.
Each plate rests on small microscrews.

SHELVING & CABINET SETS

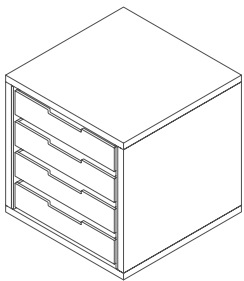
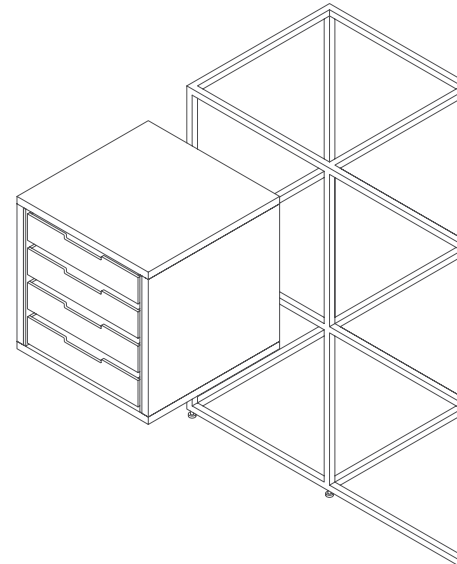

18 mm MDF construction
4 acrylic trays
369x369x400 mm / 48 Ø
STK.WBT4 340,00 €

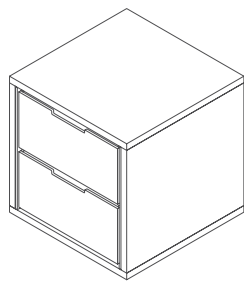

18 mm MDF construction
2 acrylic drawers
369x369x400 mm
STK.WBD2 330,00 €

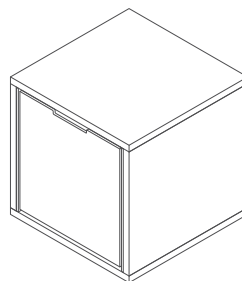

18 mm MDF construction
1 acrylic drawer
369x369x400 mm
STK.WBD1 280,00 €

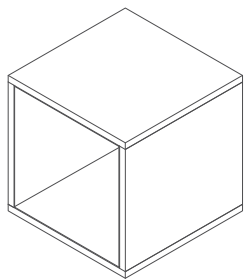

18 mm MDF construction
Box
369x369x400 mm
STK.WB 145,00 €

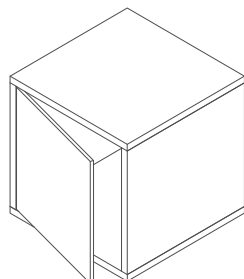

18 mm MDF construction
Box with doors
369x369x400 mm
STK.WBDO 205,00 €



Detail

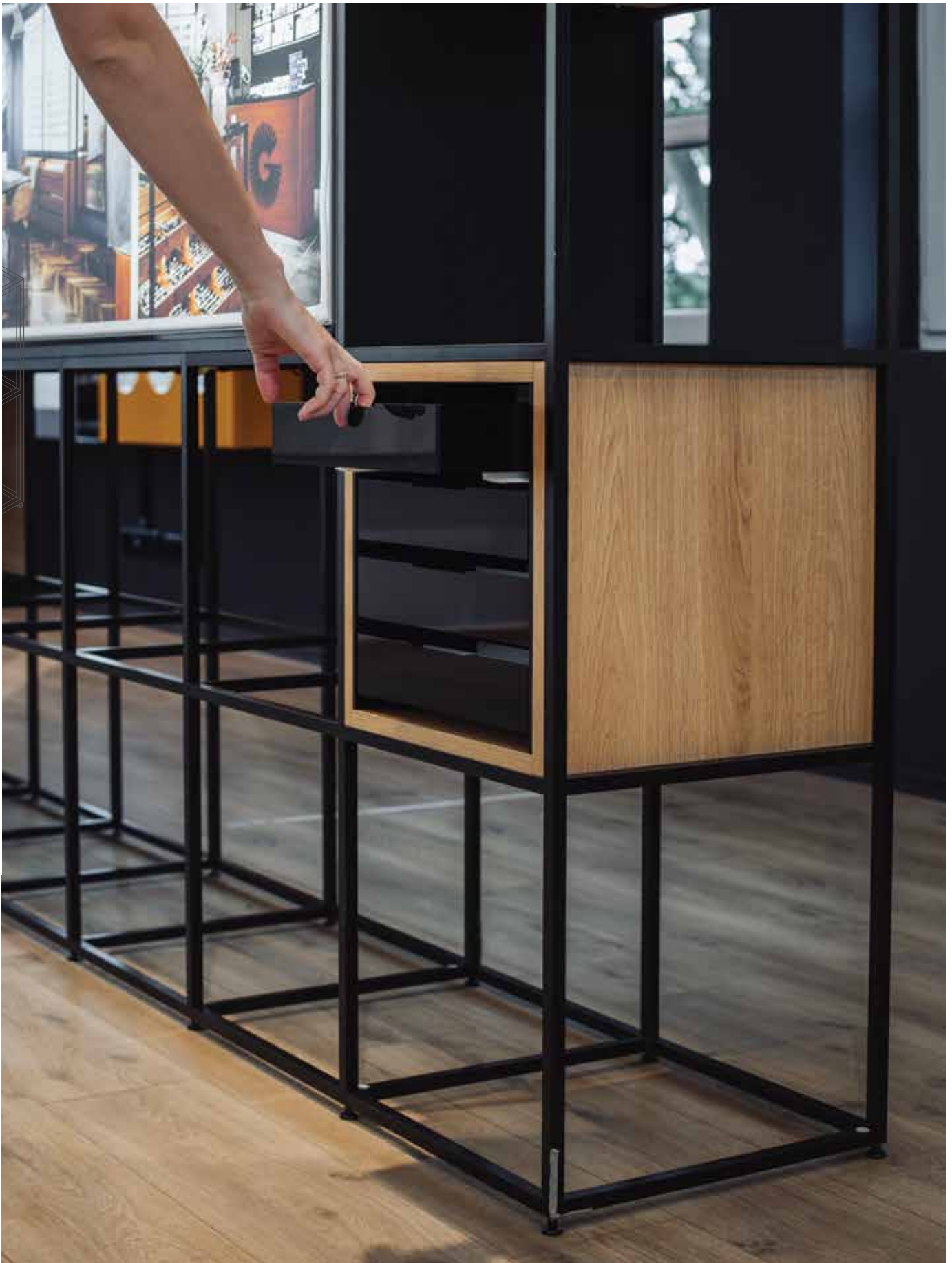

INSERT SHELVING SETS

This drawer set must be combined with the insert plate or top plate above it.

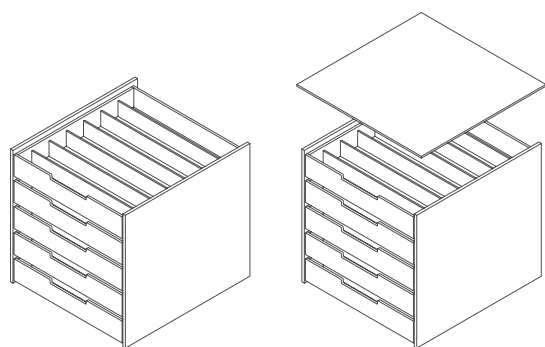

5 mm acrylic construction
5 acrylic drawers
369x369x400 mm / 60 Ø
STK.D5 449,00 €

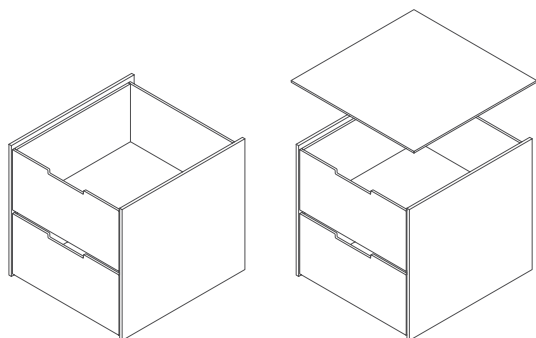

5 mm acrylic construction
2 drawers
369x369x400 mm / 50 Ø
STK.D2 305,00 €

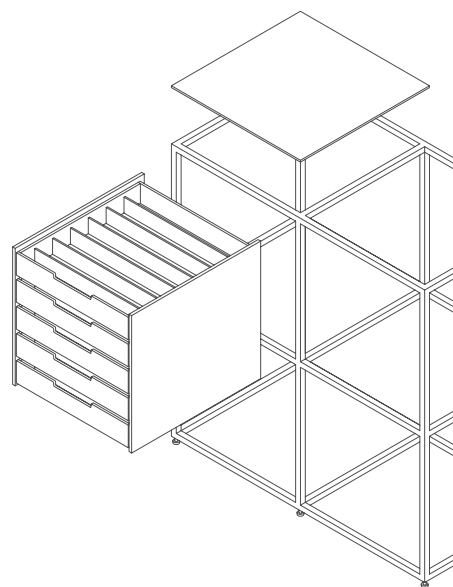



INSERT ELEMENTS & ACCESSORIES

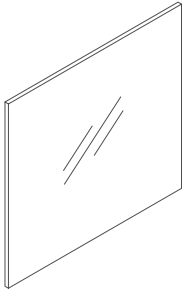

Side mirror
369x369x10 mm
STK.SPM 85,00 €

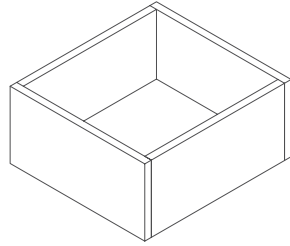

Decorative box (multipurpose; plants etc.)
369x180x400 mm
STK.WBL 98,00 €

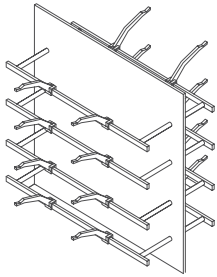

White acrylic rotating plate with Clear Look bars and rotating auto stop feature. This feature is not available for shop window displays.
STK.CL16 / 2-sided 160,00 €
369x369x370 mm / 16 ∅

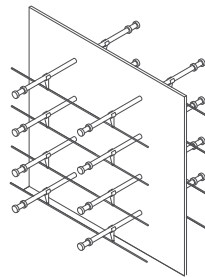

White acrylic rotating plate with Multi Pin System and rotating auto stop feature. This feature is not available for shop window displays.
STK.MP16 / 2-sided 160,00 €
369x369x370 mm / 16 ∅



ROTATING
AUTO STOP
FEATURE

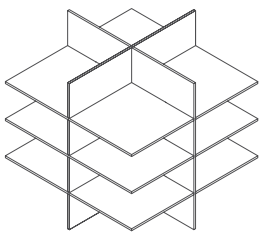

Cross shelf
Transparent 5 mm acrylic/black edges
369x369x370 mm / 12 ∅
STK.CS 160,00 €



Detail

















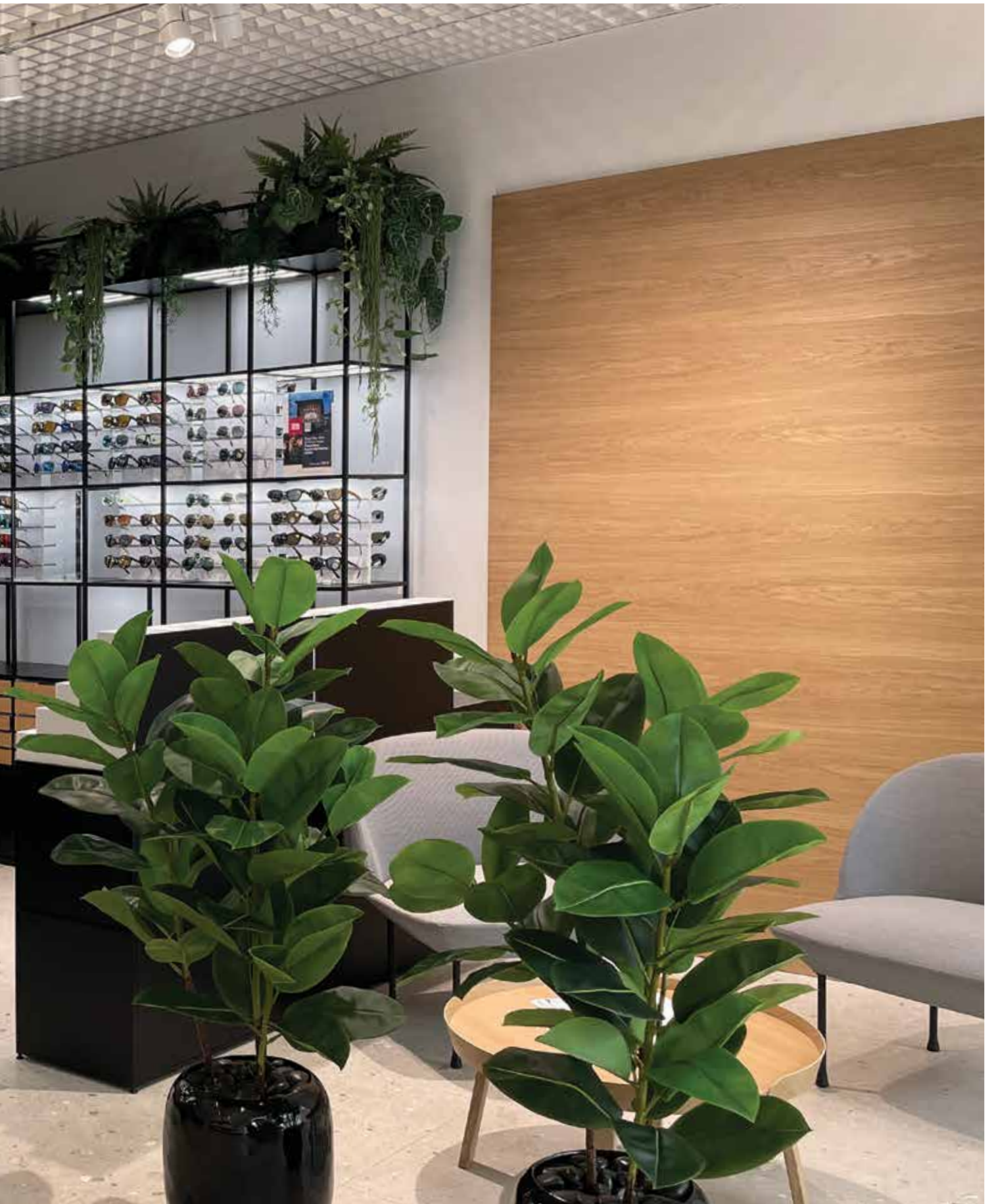









DISPLAYS WITH RODS

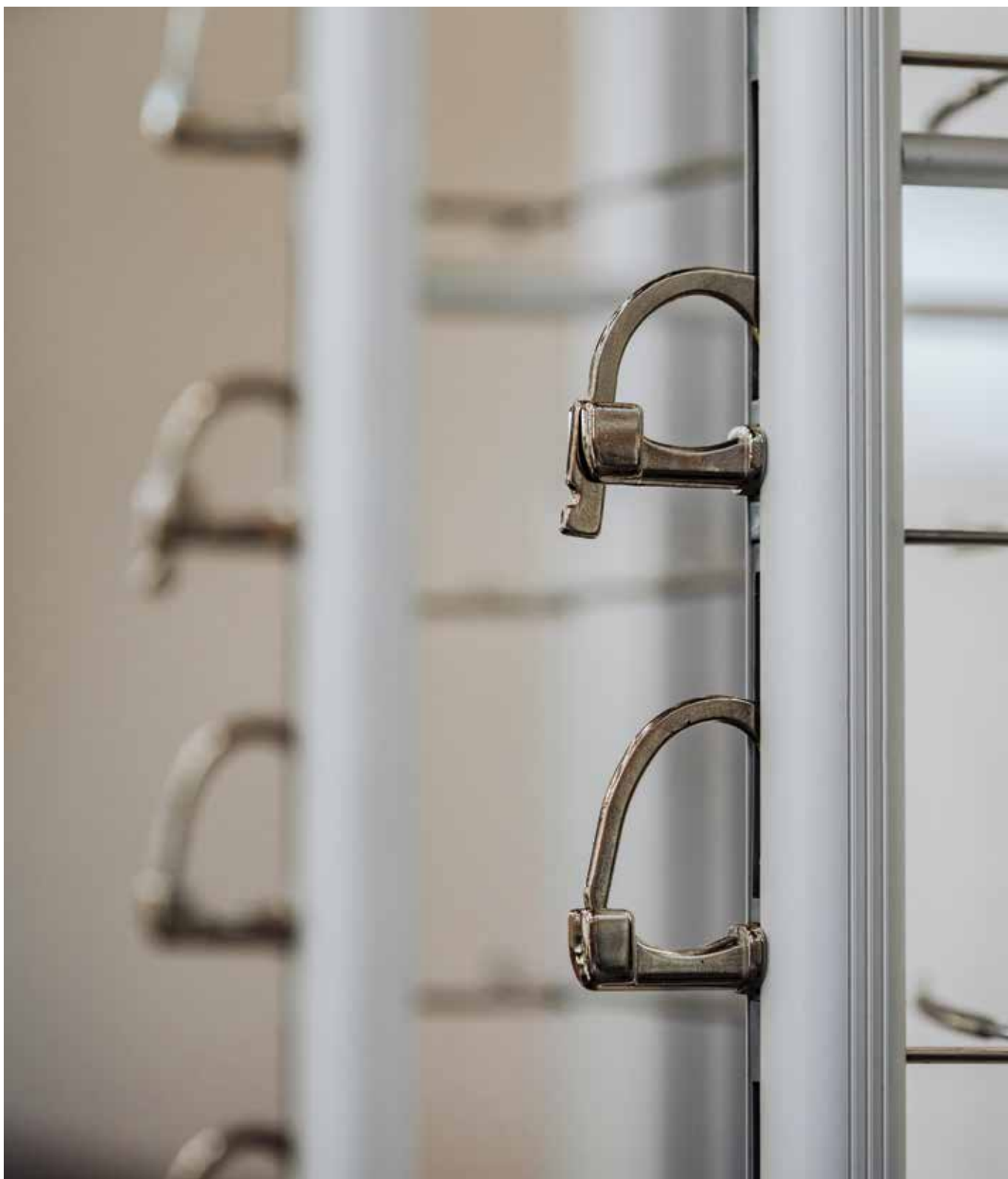

DISPLAYS WITH RODS

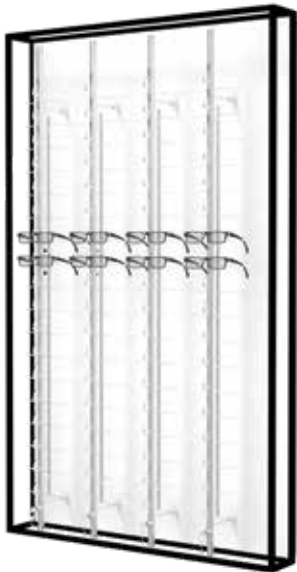

CONSTRUCTION

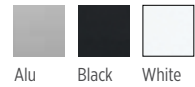

PANEL



Rod decor

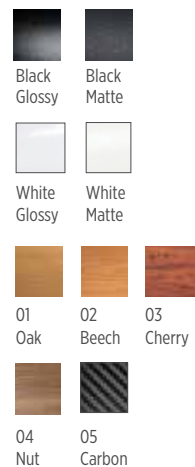

 Rotating plates

Wall display with rods

Wall construction, powder coated aluminium — black
White acrylic plate with 4 rods with white LED
930x1530x230 mm / 72 ⌀

| | | |
|--------------|-------------------|-------------------|
| lockable | STK.WP.4.L | 1.580,00 € |
| non-lockable | STK.WP.4.O | 1.320,00 € |

Display with rods

Freestanding construction, powder coated aluminium — black
2 rotating acrylic plates with 8 rods
930x1530x400 mm / 144 ⌀
lockable **STK.WP.8.R.L** **2.420,00 €**
non-lockable **STK.WP.8.R.O** **1.880,00 €**

Cabinet in decor / 3 drawers with handles / inlets included
STK.FB3.90 930x565x400 mm **849,00 €**

Advertising LED-Box in decor / custom logo
STK.P.A.90 930x235x400 mm **190,00 €**



A.RR.LH3 18,00 €
Logo holder / 72x58 mm
A.LH3.STC 5,30 €
Self-adhesive 3D logo sticker
with imprint / 72x58 mm



A.RR.LH4 18,00 €
Logo holder — magnetic.
A.LH4.STC 4,20 €
Magnetic front.



A.RR.ADP 13,00 €
Hook adapter for small eye-
glasses / 20 pieces.

SHELVING DISPLAYS



SHELVING DISPLAYS



Shelving display

Panel – white matte acrylic
 Powder coated aluminium construction – black
 7 LED shelves / white acrylic*
 5 white logo holders with imprint included

930x1530x320 mm **STK.S.7** **1.580,00€**



Shelving display

Panel – white matte acrylic
 Powder coated aluminium construction – black
 10 LED shelves / white acrylic*
 5 white logo holders with imprint included

930x1530x320 mm **STK.S.10** **1.880,00€**

CONSTRUCTION

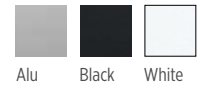

PANEL



Acrylic logo holder /168x100 mm
 White acrylic / print included.
STK.MO.L.L.H **15,00 €**



Shelves can be made with a magnetic base. Combine magnetic shelves with magnetic eyewear holders and double the presentation capacity.

Magnetic frame holders.
 Transparent acrylic
A.S.MGH1
 Aluminium
A.S.MGH2

11,00€

11,00€





MOSAIC SHELVES



MOSAIC SYSTEM

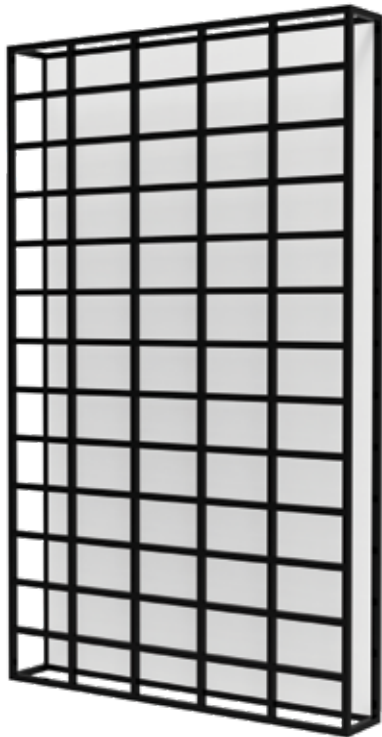

Back panel in white matte acrylic
Aluminium construction
STK.MOS.L 930x1530x320 mm **590,00 €**

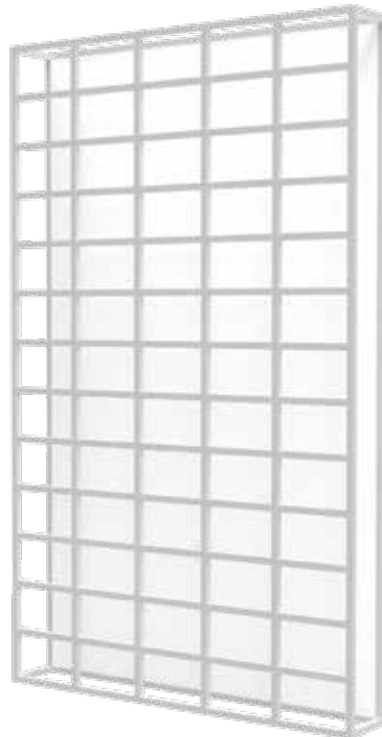

White LED canvas as back panel
Aluminium construction
STK.MOS.C 930x1530x320 mm **1.490,00 €**

The system consists of a back panel (acrylic - white matte or LED canvas) and an aluminium structure. The structure includes 65 compartments where various shelves and accessories can be placed. The system is electrified, and the layout is fully customizable.

CONSTRUCTION

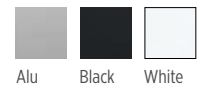

PANEL



Acrylic - white matte

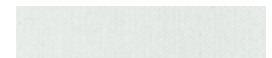

LED canvas (optional print)

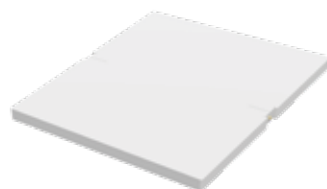
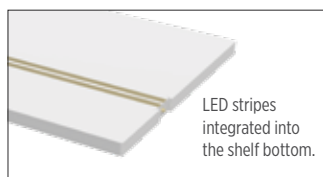

LED shelf, white matte acrylic.
STK.MO.L.S 170x200 mm **31,00 €**

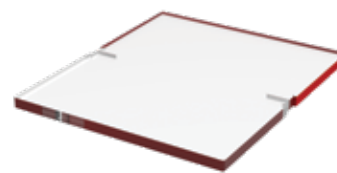

Shelf in transparent acrylic, other colours available.
STK.MO.C.S 170x200 mm **16,00 €**

LED canvas available with print on request.



MOSAIC DISPLAYS



Logo holder
White acrylic / print included
168x100 mm
STK.MO.L.L.H 15,00 €

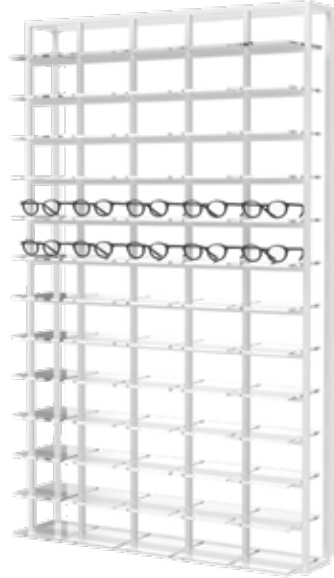

Logo holder
Transparent acrylic / print included
168x100 mm
STK.MO.C.L.H 15,00 €

Mosaic wall display

White matte acrylic plate / black powder coated aluminium construction
65 LED shelves / white acrylic / 65 Ø
MOS1 930x1530x320 mm **2.605,00 €**

Mosaic wall display

LED canvas panel / white powder coated aluminium construction
65 shelves / transparent acrylic / 65 Ø
MOS2 930x1530x320 mm **2.530,00 €**



Acrylic mirror.
STK.MO.M
168x30x217 mm

38,00 €



Tablet holder, tablet included.
White acrylic.
STK.MO.CAM
170x330 mm

1.190,00 €



LED advertising plate with exchangeable graphics (sold separately), magnetic fixation.

STK.MO.L.A.2/1 180,00 €
168x30x217 mm
STK.MO.L.A.3/2 260,00 €
366x30x330 mm

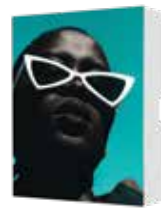

Advertising plate, exchangeable graphics (sold separately), magnetic fixation.

STK.MO.C.A.2/1 130,00 €
168x30x217 mm
STK.MO.C.A.3/2 180,00 €
366x30x330 mm

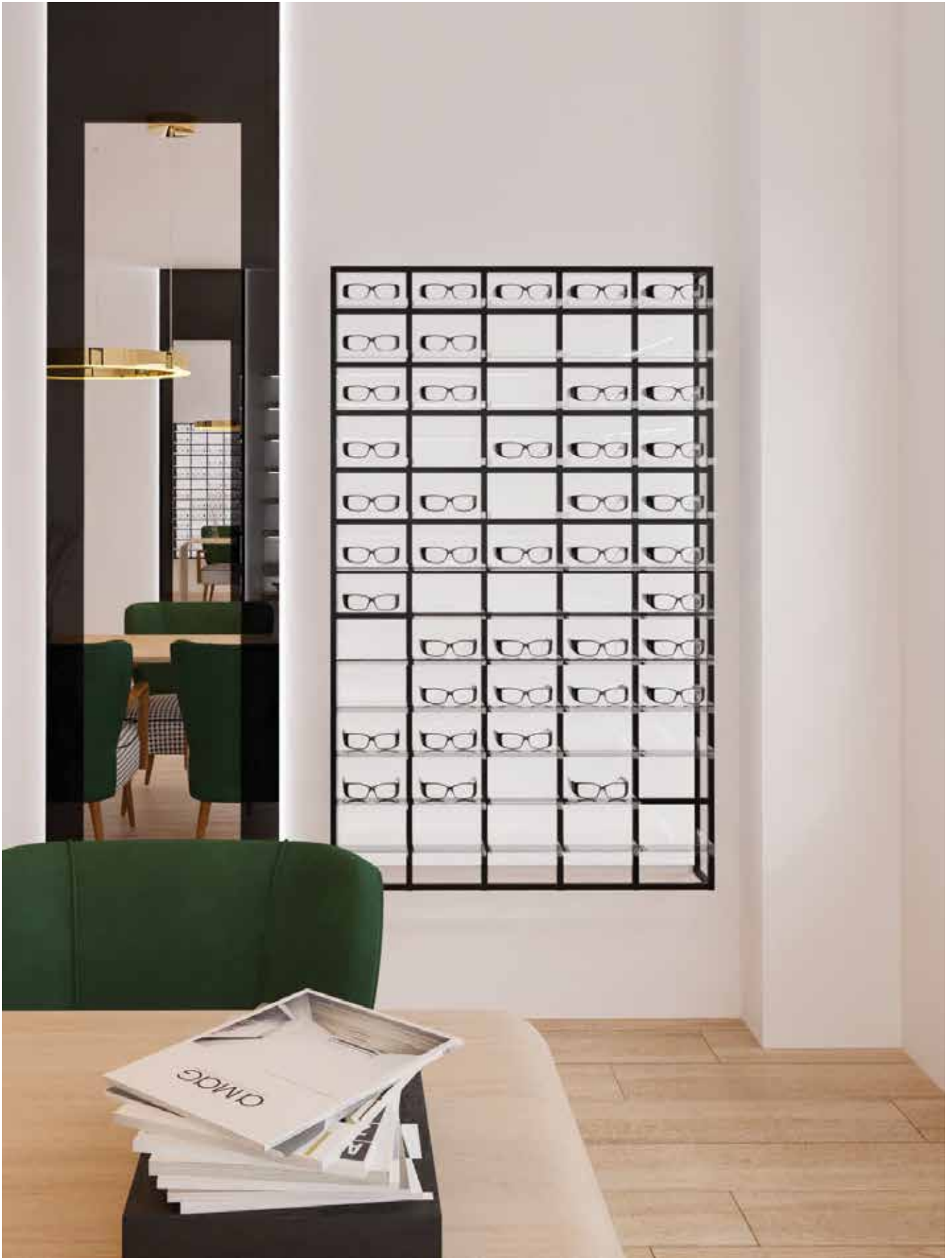

CLEAR LOOK DISPLAYS



CLEAR LOOK DISPLAYS

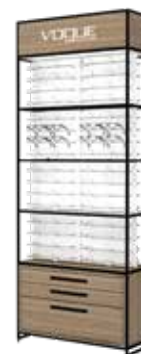

 Rotating plates

Clear Look LED wall display

Wall construction, powder coated aluminium – black
White matte acrylic plate / 15 white LED bars / 75 \varnothing
Logo holders are sold separately

STK.WP.CL.15 930x1530x335 mm **1.595,00 €**

Clear Look LED display

Freestanding construction, powder coated aluminium – black
4 acrylic LED insert plates / integrated white LED stripes
8 white matte acrylic plates – rotating / 64 bars / 128 \varnothing

STK.WP.CL16.R 930x1530x400 mm **2.193,00 €**

Cabinet in decor / 3 drawers with handles / inlets included

STK.FB3.90 930x565x400 mm **849,00 €**

Advertising LED-Box in decor / custom logo

STK.P.A.90 930x235x400 mm **190,00 €**



Lockable frame holder.

A.CL.SL **16,00 €**

Magnetic key.

A.SL.MK **13,00 €**

Sliding acrylic mirror.

A.CL.M 140x240 mm **18,00 €**

Logo holder / exchangeable graphics.

A.CL.LHI 140x80 mm **7,40 €**

MULTI PIN DISPLAYS



MULTI PIN DISPLAYS

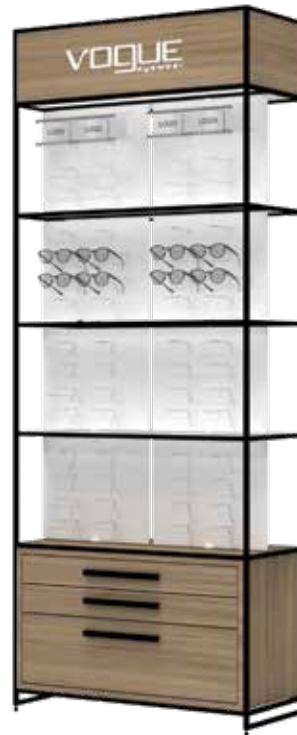
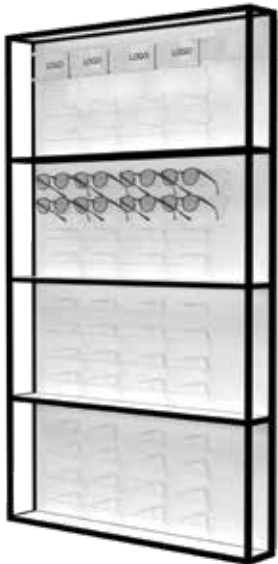

 Rotating plates

Multi Pin LED wall display

Wall construction, powder coated aluminium – black
4 acrylic LED insert plates / integrated LED stripes
4 white matte acrylic plates / 64 pins / 64 
Logo holders are sold separately

STK.WP.MP.16 930x1530x330 mm **1.575,00 €**

Freestanding Multi Pin LED display

Freestanding construction, powder coated aluminium – black
4 acrylic LED insert plates / integrated LED stripes
8 white matte acrylic plates – rotating / 128 pins / 128 
Logo holders are sold separately

STK.WP.MP.16.R 930x1530x400 mm **2.153,00 €**

Cabinet in decor / 3 drawers with handles / inlets included
STK.FB3.90 930x565x400 mm **849,00 €**

Advertising LED-Box in decor / custom logo
STK.P.A.90 930x235x400 mm **190,00 €**

ADVERTISING ELEMENTS & CABINETS

CONSTRUCTION



Alu Black White

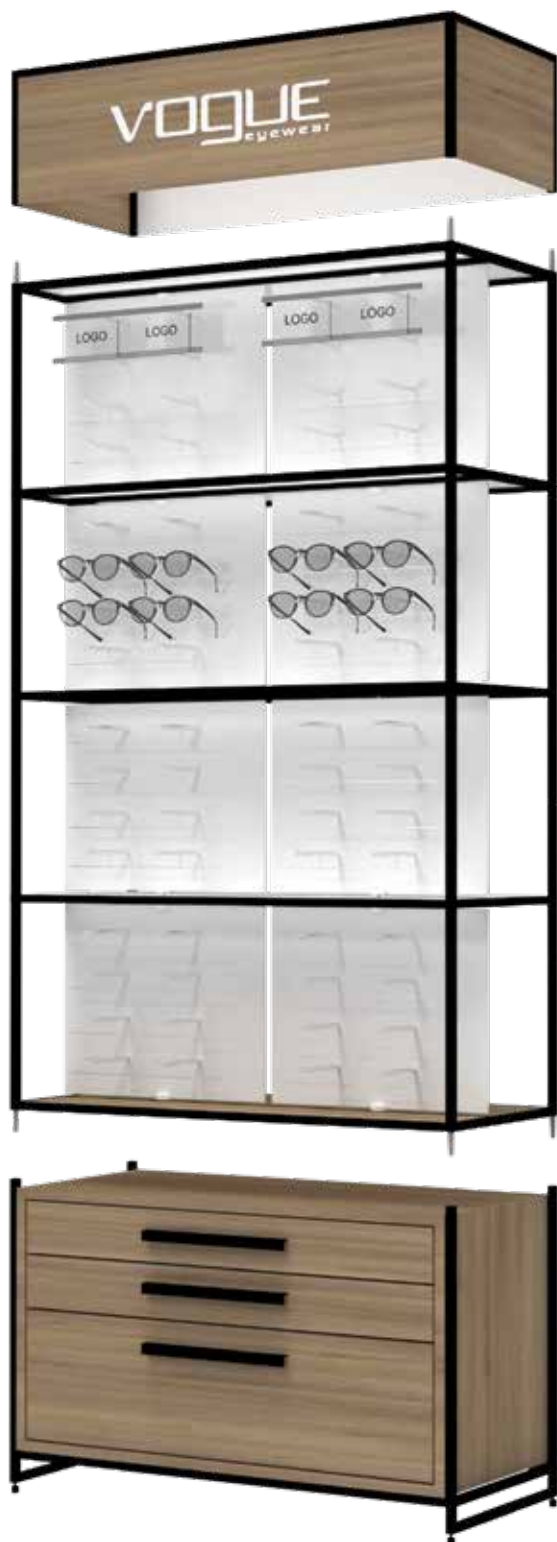

Various display combinations available



Rotating plates

ADVERTISING ELEMENTS

Advertising LED-Box



The advertising LED box is mounted on the wall displays.

Advertising LED box in decor / custom brand cutout. For freestanding and wall-mounted displays.

LED box for freestanding displays
STK.FP.A.90 190,00€
 930x235x400 mm

LED box for wall displays
STK.WP.A.90 190,00€
 930x235x150 mm

CABINETS

Cabinets for wall displays



Freestanding cabinets with 3 or 4 drawers with handles. Various décors available.

930x505x400 mm
 2 drawers **STK.B2.90** 749,00€
 3 drawers **STK.B3.90** 849,00€
 4 drawers **STK.B4.90** 949,00€

Cabinets for freestanding displays



Cabinets are mounted on the wall displays.

Freestanding cabinets with 3 or 4 drawers with handles. Various décors available.

930x505x400 mm
 2 drawers **STK.FB2.90** 749,00€
 3 drawers **STK.FB3.90** 849,00€
 4 drawers **STK.FB4.90** 949,00€





SHOP WINDOW DISPLAYS

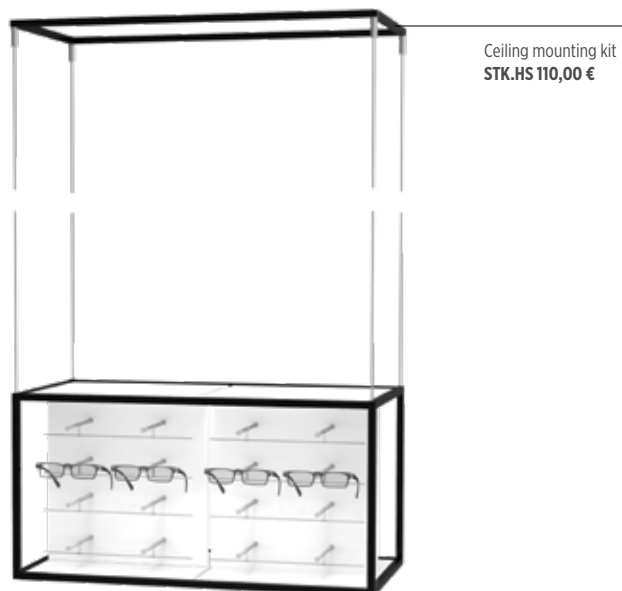
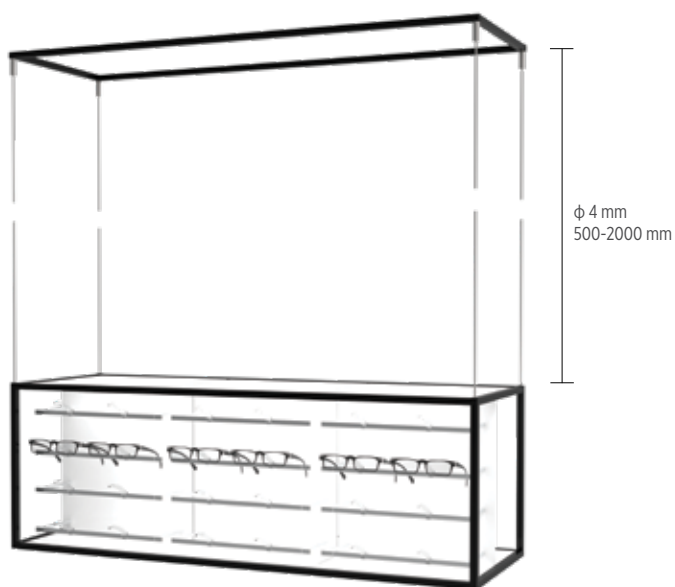

Clear Look LED shop window display

LED construction with ceiling mounting kit in powder coated aluminium - black

3 acrylic LED insert plates / integrated LED stripes

3 acrylic insert bottom plates

3 white matte acrylic plates / 24 bars / 48 ∅

STK.HS.CL.24 1200x400x400 mm **1.155,00 €**

Multi Pin LED shop window display

LED construction with ceiling mounting kit in powder coated aluminium - black

2 acrylic LED insert plates / integrated LED stripes

2 acrylic insert bottom plates

2 white matte acrylic plates / 32 pins / 32 ∅

STK.HS.MP.32 800x400x400 mm **828,00 €**

Various displaying options.

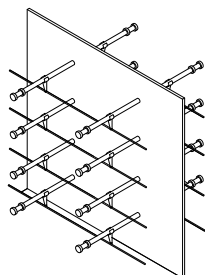
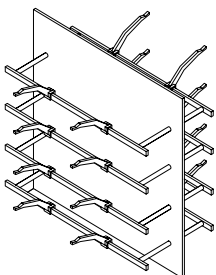

White acrylic plate with Clear Look bars.
STK.CL16 / 2-sided **160,00 €**
369x369x370 mm / 16 ∅

White acrylic plate with Multi Pin System.
STK.MP16 / 2-sided **160,00 €**
369x369x370 mm / 16 ∅

Simple installation of acrylic plates.

Ceiling mounting kit.
STK.HS **110,00 €**



ISLAND DISPLAY STANDS & CABINETS



Island display stand

Black powder coated aluminium construction
 9 acrylic shelves (LED)
 6 drawers in black acrylic (optional in decor)
 900x1150x785 mm

| | | |
|----------------------|-----------------|-------------------|
| With LED lighting | STKE.PK1 | 2.759,00 € |
| Without LED lighting | STK.PK1 | 2.119,00 € |

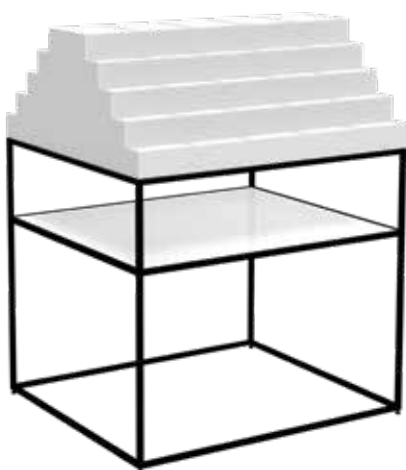

Island display stand

Black powder coated aluminium construction
 9 acrylic shelves (LED)
 1 large acrylic shelf (optional in decor)
 900x1150x785 mm

| | | |
|----------------------|-----------------|-------------------|
| With LED lighting | STKE.PK2 | 1.839,00 € |
| Without LED lighting | STK.PK2 | 1.119,00 € |



Island display stand

Black powder coated aluminium construction
 9 acrylic shelves (LED)
 10 drawers in decor
 400x1150x785 mm

| | | |
|----------------------|-----------------|-------------------|
| With LED lighting | STKE.PK3 | 2.137,00 € |
| Without LED lighting | STK.PK3 | 1.698,00 € |



Island display stand

Black powder coated aluminium construction
 8 lockable frame holders on an acrylic plate
 10 drawers in decor (optional in acrylic)

785x985x400 mm **STK.PK4** **1.507,00 €**



Island display cabinet

Black powder coated aluminium construction
 2 cross shelves in transparent acrylic
 20 removable drawers in white acrylic
 (optional in decor)
 400x1555x785 mm

With LED lighting **STKE.PV1** **3.113,00 €**
 Without LED lighting **STK.PV1** **2.713,00 €**



Cabinet on wheels

10 removable drawers / 120 Ø

405x905x405 mm **STK.B10** **1.001,00 €**

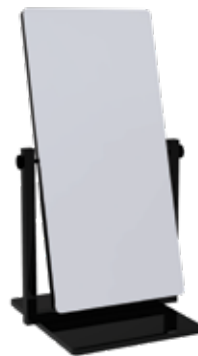

Rotating table mirror

Black powder coated aluminium construction

196x305x196 mm **A.M1** **206,00 €**

WORKING PROCESS

Depending on the requirements of your project, we can offer various planning methods. After defining the planning method, the working process flows simply from design to production and final assembly.

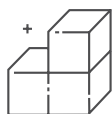

PLANNING

GO CONFIGURE

DESIGN TEAM

BESPOKE DESIGN

For the Struktura system, there is a simple design software — a configurator that includes all standard elements with the option of personalization. Through a very user-friendly interface and accompanying instructions, you can now easily configure the desired combination.

If you don't have your own designer or architect, we can configure the desired combination for you. We will simply ask you to fill out a short questionnaire, to identify your needs and preferences.

Struktura is a system whose applications and functionalities grow and evolve every day. If you need a specific piece that is not included in our catalog, we provide personalized design services upon request. Feel free to contact us.

OSX/WINDOWS
.obj

Request a free configurator version at
info@presenta-nova.hr

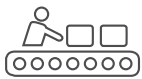

TECHNICAL SPECIFICATIONS & PRODUCTION

The production process itself is very brief, typically taking 3 to 6 weeks. We reserve the right to extend production deadlines due to unforeseen circumstances.



SHIPPING

Due to the simplicity of the construction itself, transportation costs and delivery times are very low.



INSTALLATION

For the assembly of Struktura construction, no tools are required, but we will include a micro-screwdriver and a hammer for the insert elements. Our team of designers and engineers is available at any time to assist you with the installation process.

SHOWROOM



Our newly renovated 220 m2 showroom is located in Mannheim, Germany, just an hour's drive from Frankfurt Airport. The showroom is located in an up-and-coming design district, a former industrial area, and is surrounded by many design companies and popular venues.

Start your project in a creative and inspirational atmosphere:
Explore the variety of colors, textures and materials available.
Explore the possibilities of flooring and wall cover solutions.
Browse through our portfolio of projects and case studies.



Presenta Nova GmbH
Industriestraße 35
D-68169 Mannheim
+49 621 7245 0040

Opening hours
Monday - Friday
09.00 - 17.00

info@presenta-nova.de
www.presenta-nova.com
@presenta.nova

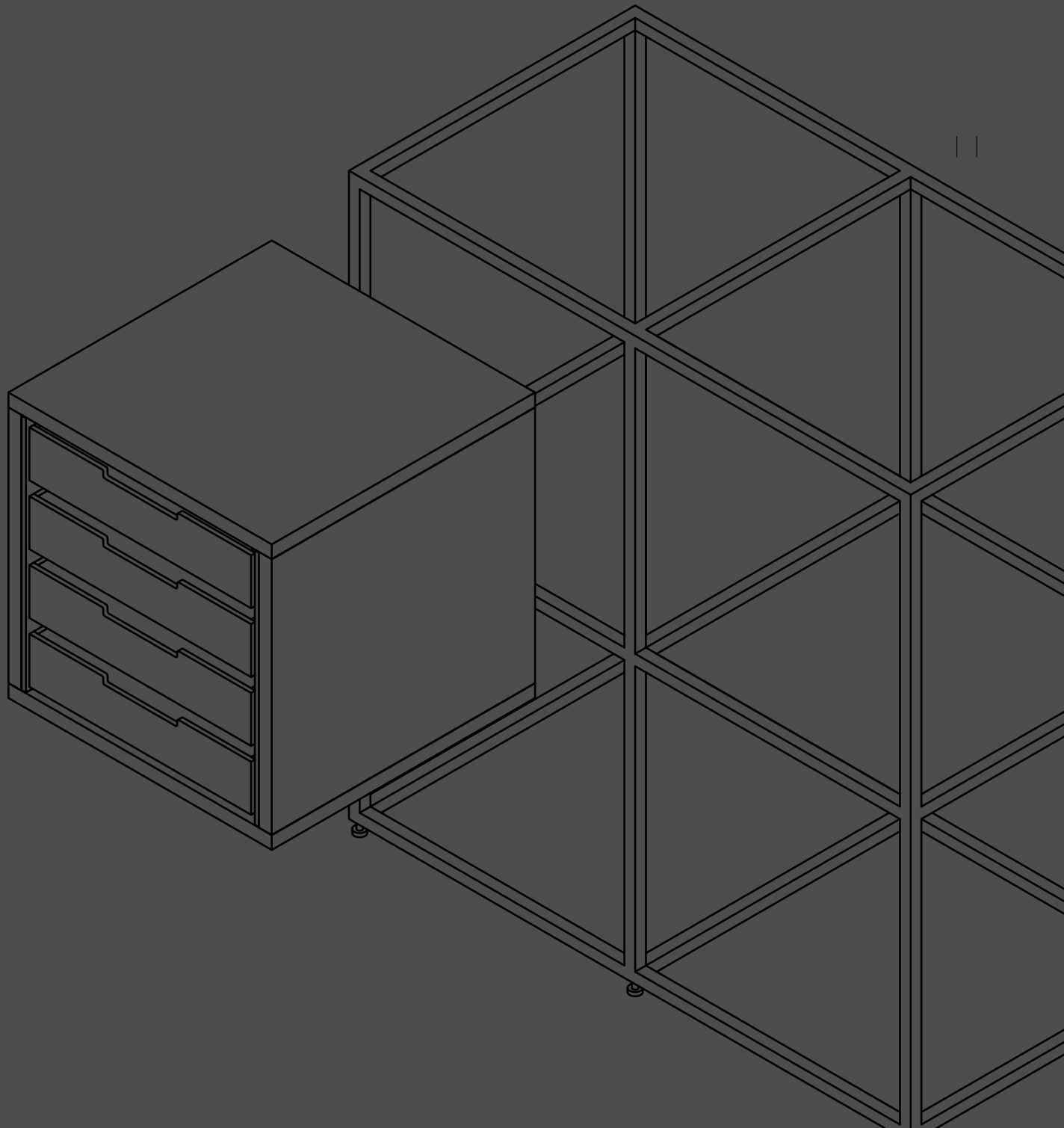

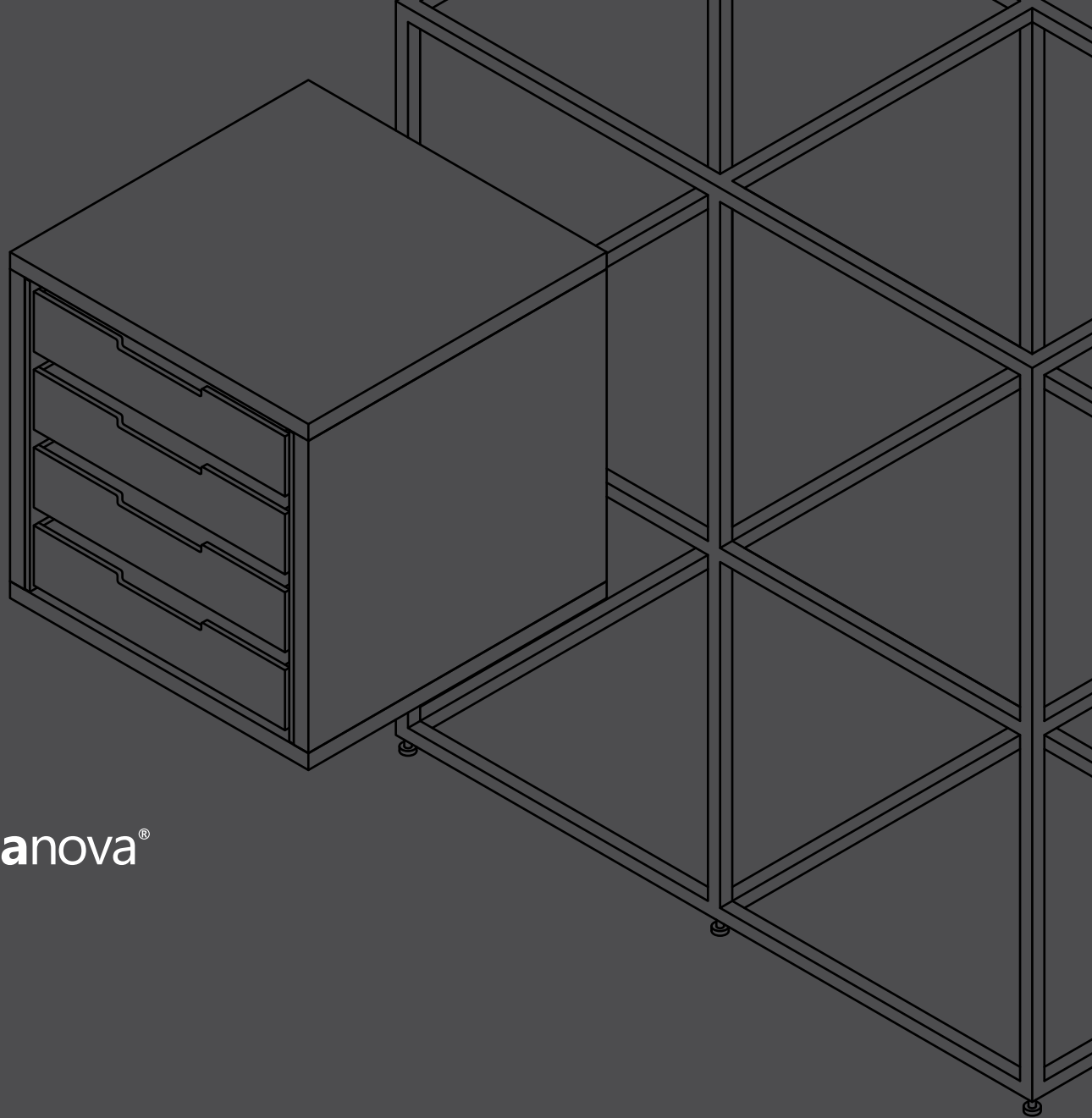

presentanova[®]

SHOWROOM

Presenta Nova GmbH
Industriestraße 17
D-68169
Mannheim
+49 621 7245 0040
info@presenta-nova.de

PRODUCTION

Presenta Nova d.o.o.
Puzeva 7
HR-10020
Zagreb
+385 1 6524 048
info@presenta-nova.hr

www.presenta-nova.com